

TV 2D100	975-1000	1900	410
TV 2D110	1075-1100	1900	480
TV 2D120	1175-1200	1900	515
TV 2D130	1275-1300	1900	520

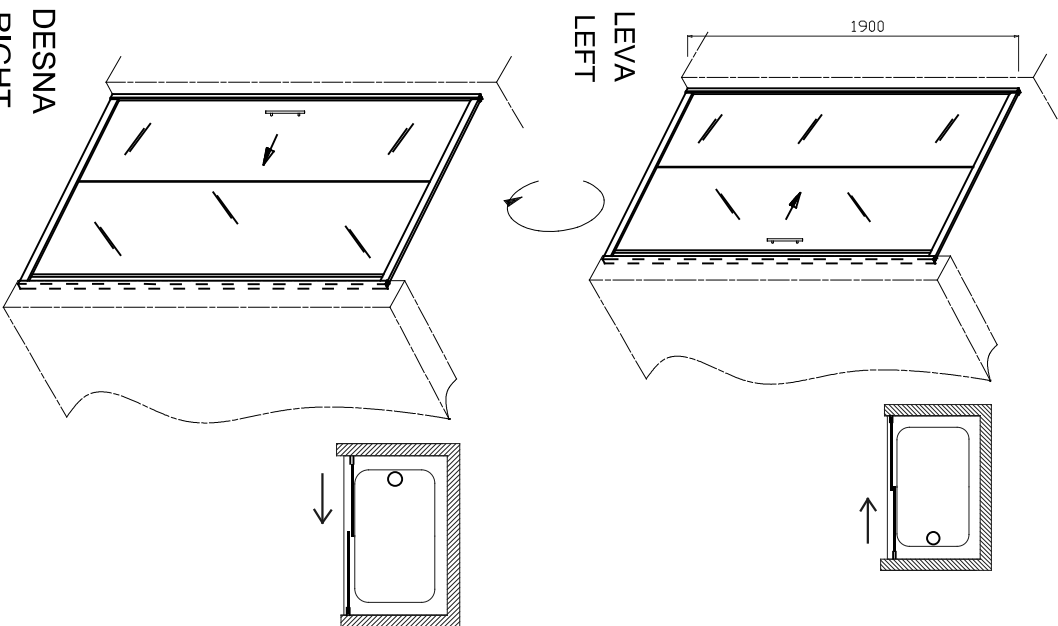

Ø6 mm

Ø3,5 mm
Ø3 mm

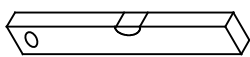
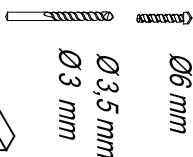

-1-

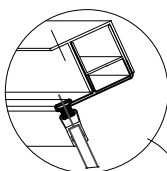
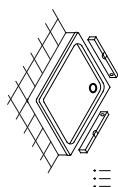

!!!
LEVA
LEFT

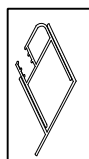
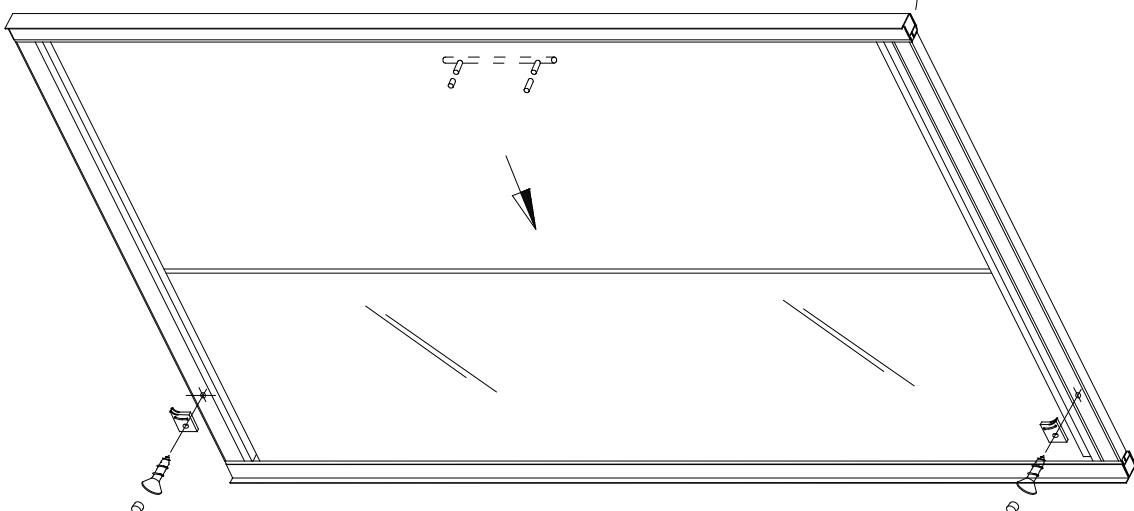

-2-

-3-

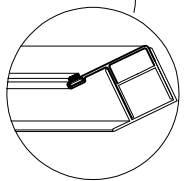
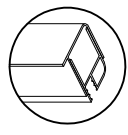
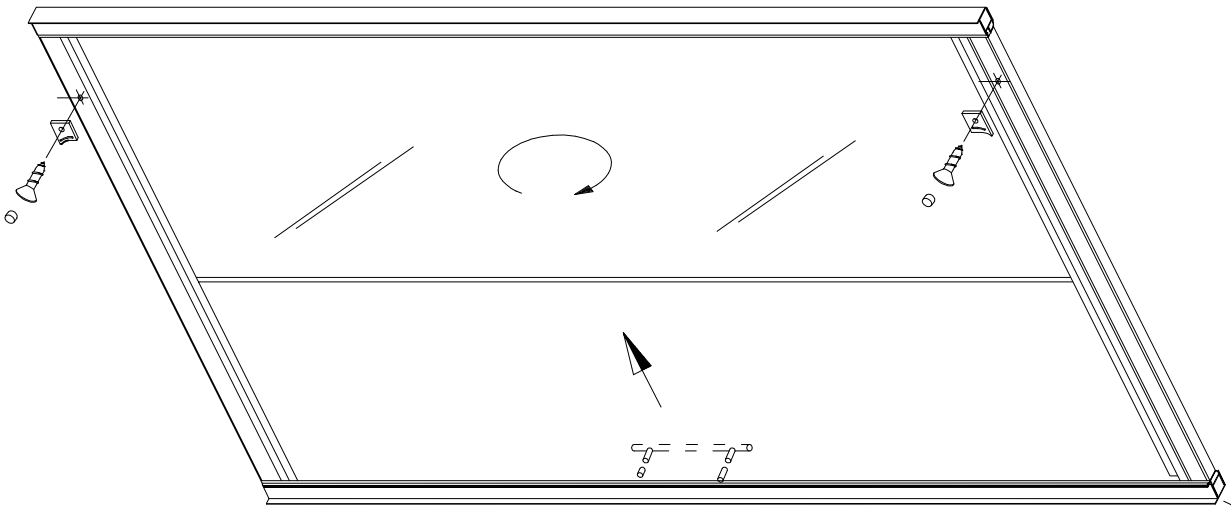

!!!
DESNA
RIGHT

-4-

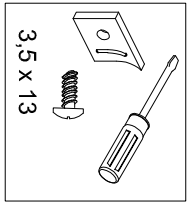
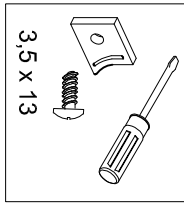
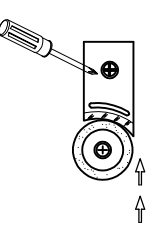
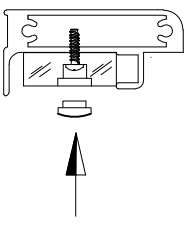
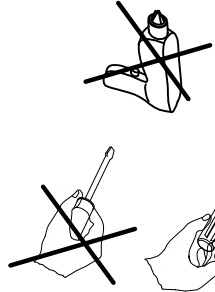
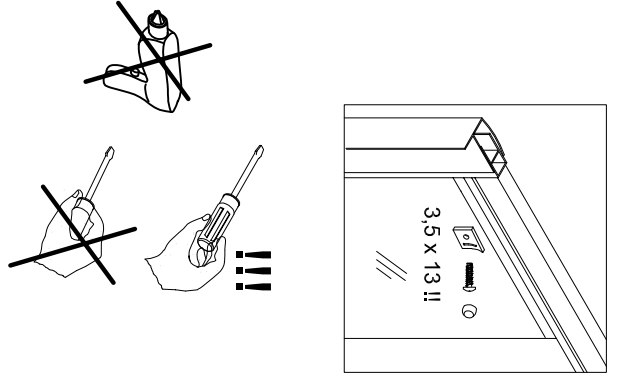
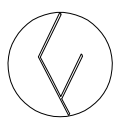
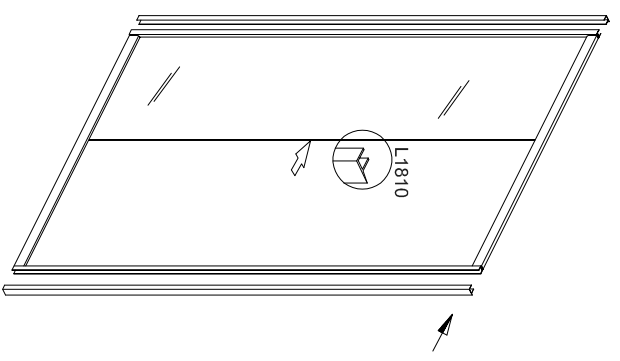

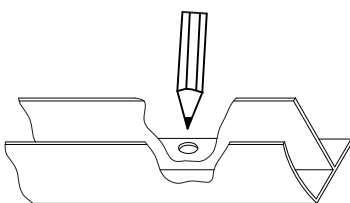
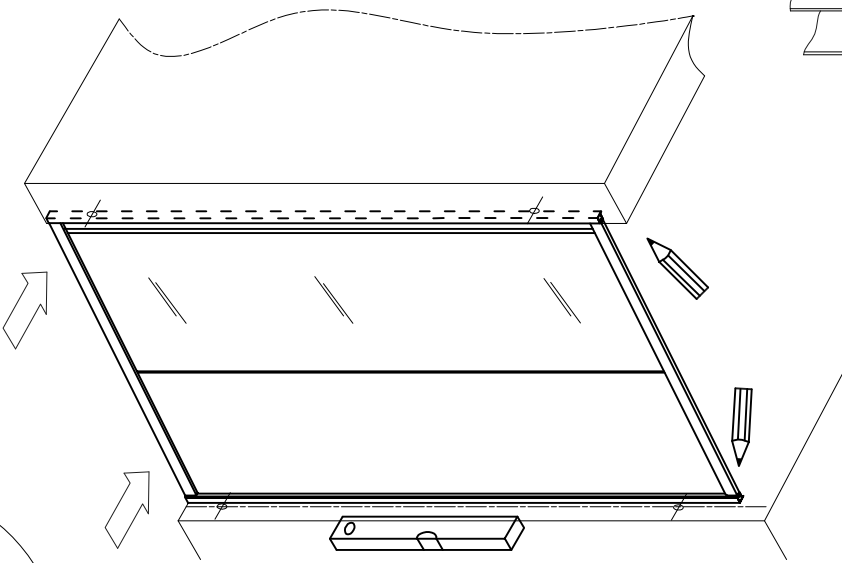
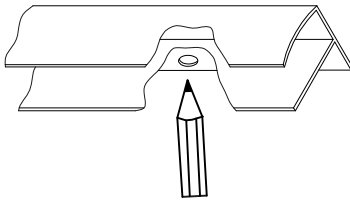
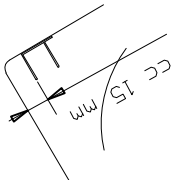

iv

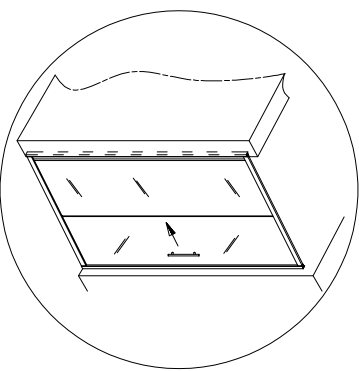







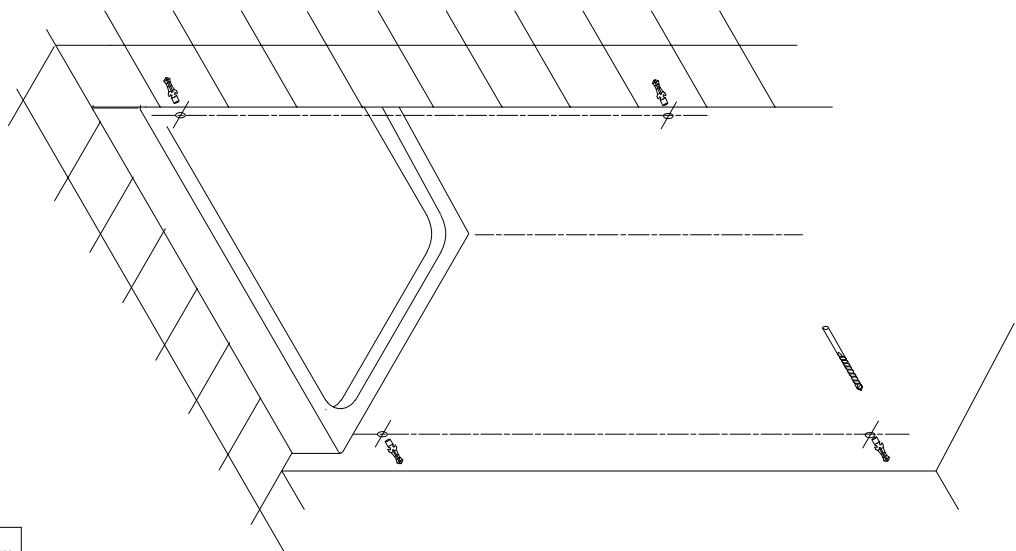





-5-



Ø 6 mm



- ①   
- ②   
- ③   
- ④   

-6-

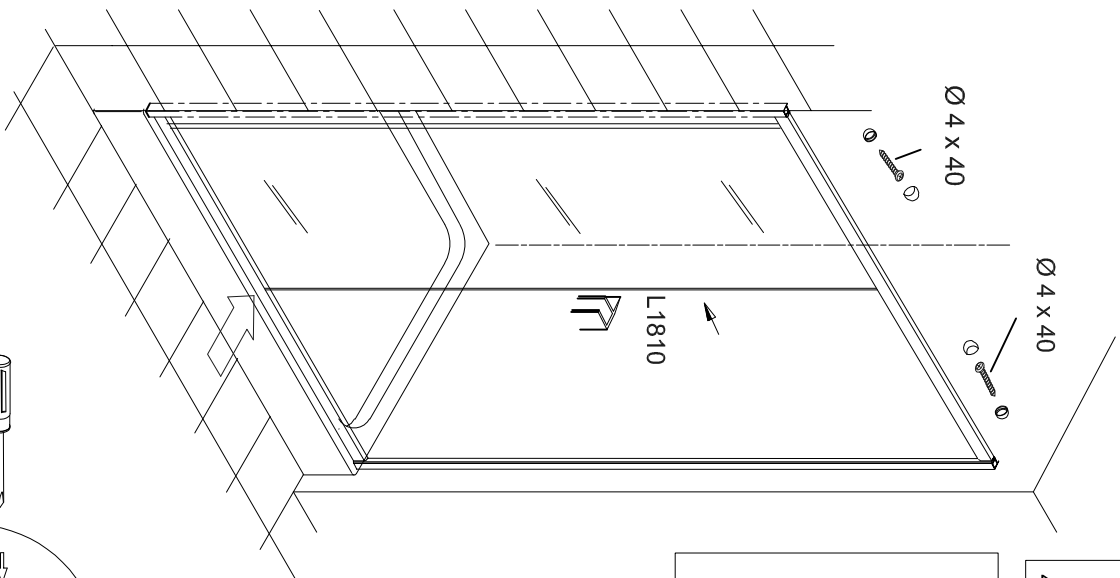
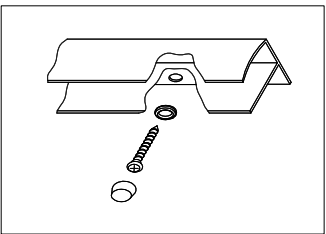

-7-

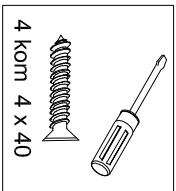
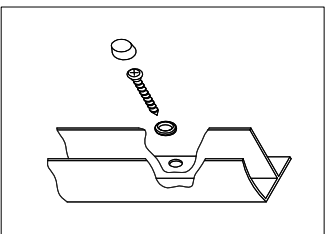
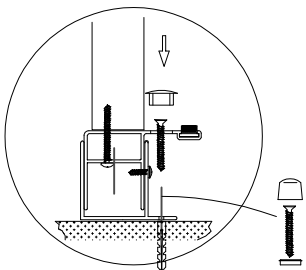

Zgoraj
Up

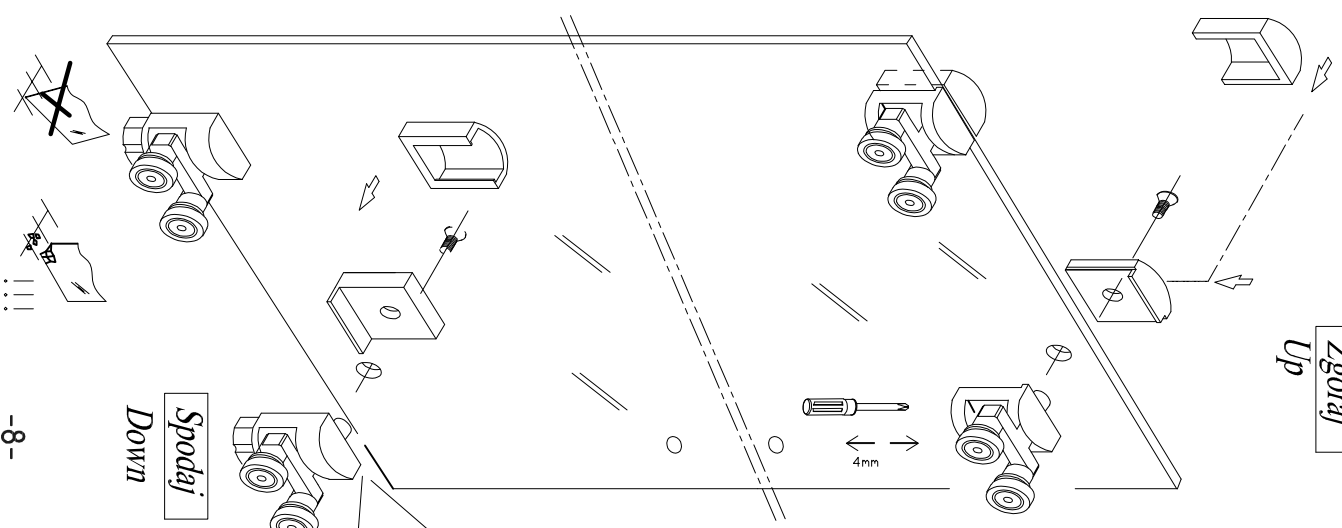

-8-

Spodaj
Down

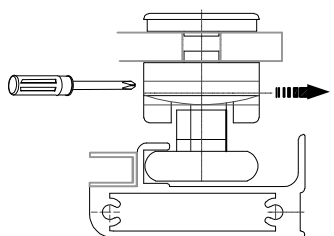
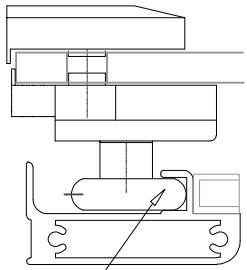
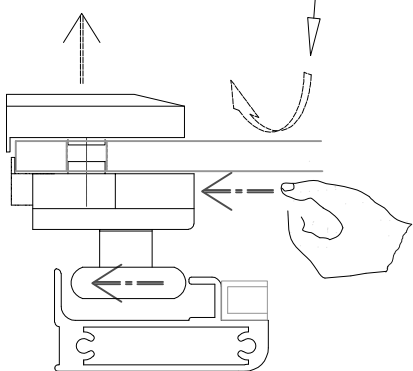

-9-

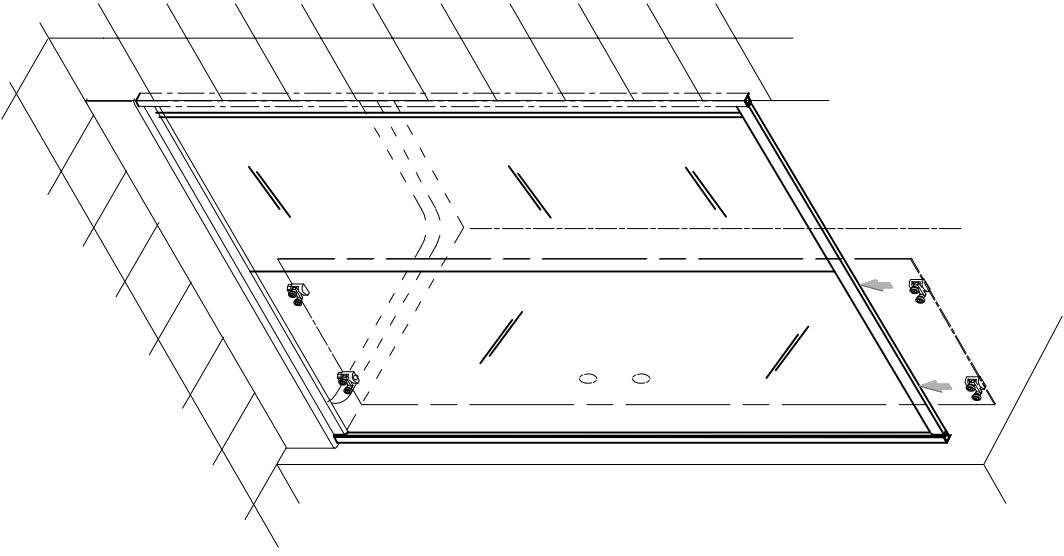

-10-

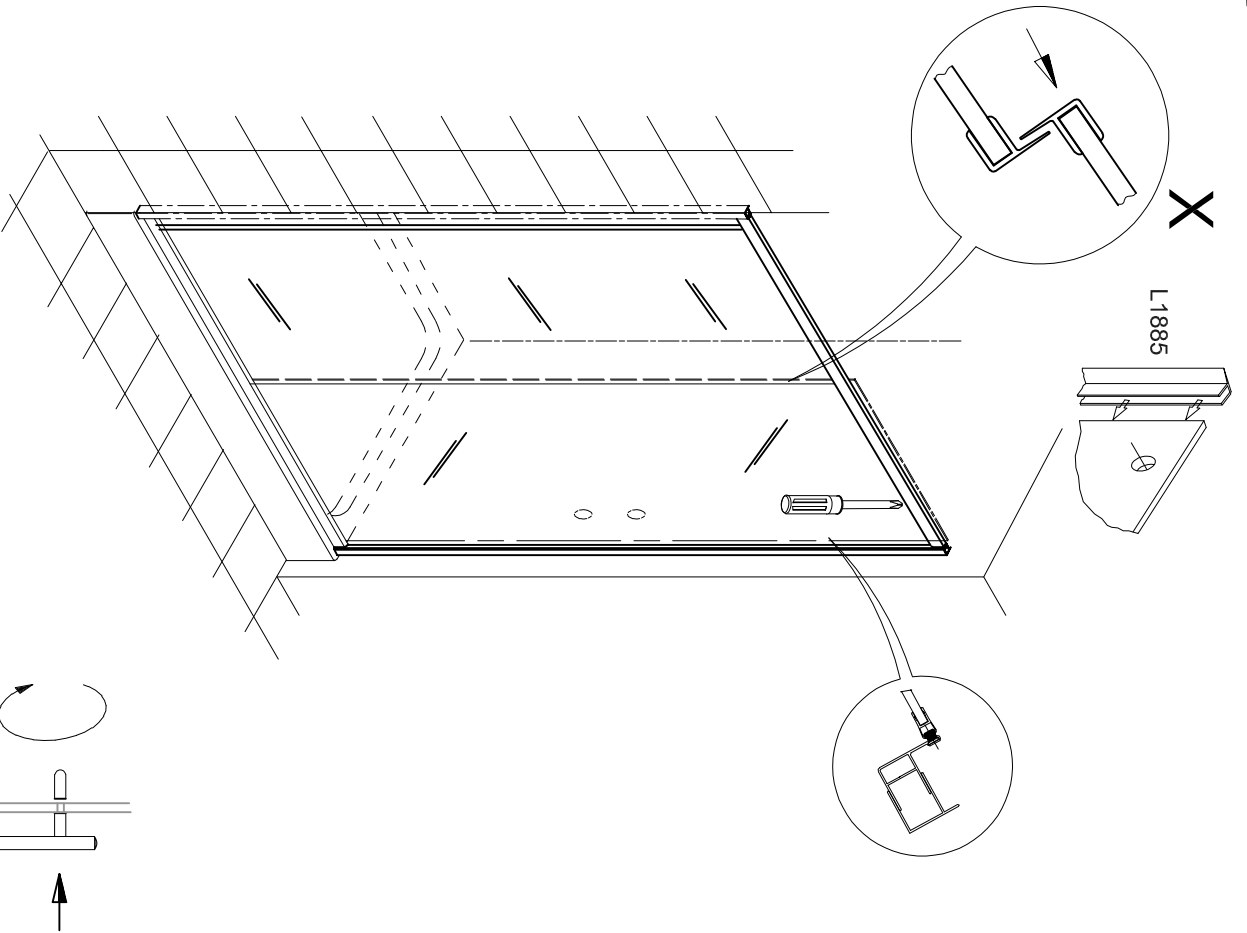



D

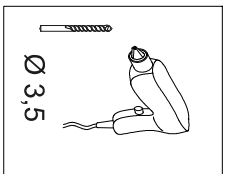
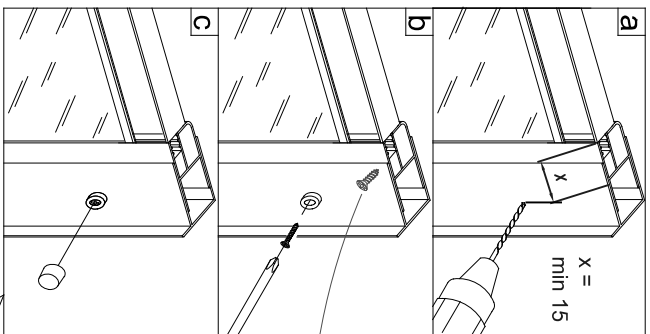

Ø 3.9x13
2X

Ø 3.5 mm

Figura 4

⊖	⊕	⊕	⊕	⊕

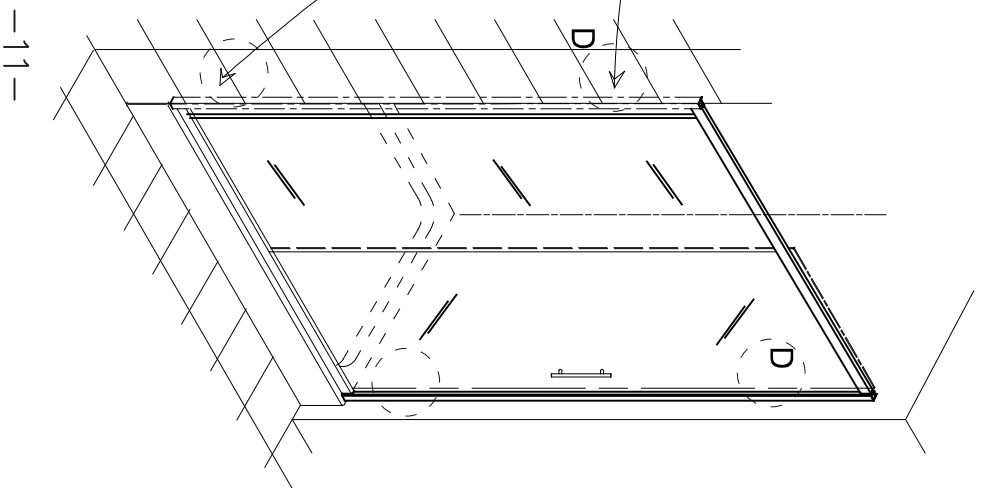

-11-

kolpa·san

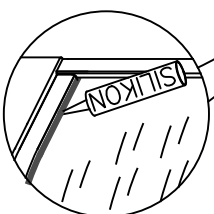
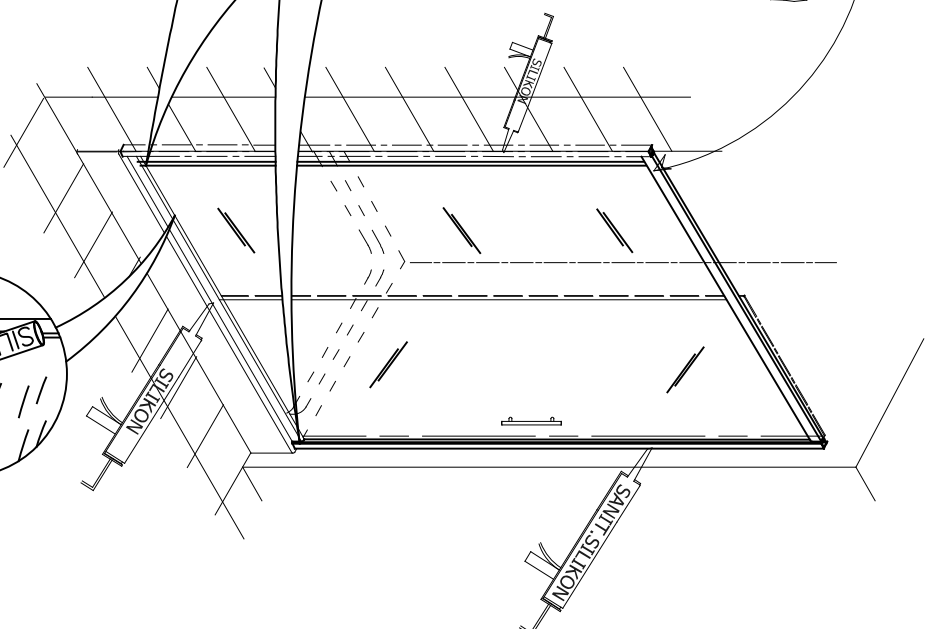
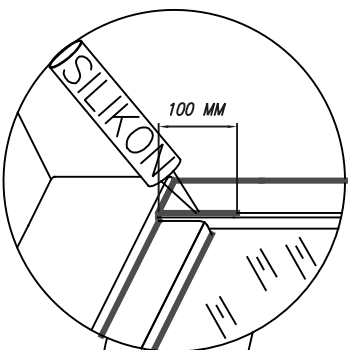
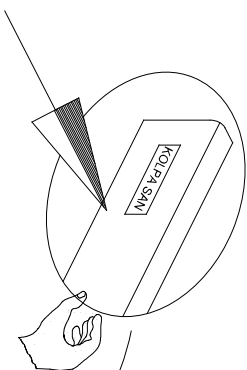

	3,5 x 13	2		8
	3,9x 13	4		8
	4 x 40	4		2
		1		2
	Ø 6x35	4		2



-12-